

# Piazza delle Cure

## COMUNE DI FIRENZE

**DIREZIONE NUOVE INFRASTRUTTURE E MOBILITA'**  
**Servizio Programmazione Mobilità e Piste Ciclabili**  
**P.O. Riqualificazione Spazi Urbani**

**RIQUALIFICAZIONE DI PIAZZA DELLE CURE**

**PROGETTO ESECUTIVO**

**Abaco arredi, pavimentazioni, particolari costruttivi**

*Responsabile del procedimento:*  
**Ing. Giuseppe Carone**

*Progettisti:*  
**Arch. Maurizio Barabesi**

*Paesaggio e verde urbano:*  
**Dott.ssa Lorella Arioli**

*Mobilità:*  
**Ing. Stefano Longinotti**

*Collaboratori:*  
**Arch. Stefano Naldi**  
**P.E. Matteo Redi**  
**Geom. Vanessa Rinaldi**



REV	DATA	DESCRIZIONE
-----	------	-------------

EMMISSIONE	10/10/2017	
------------	------------	--

# SP.7

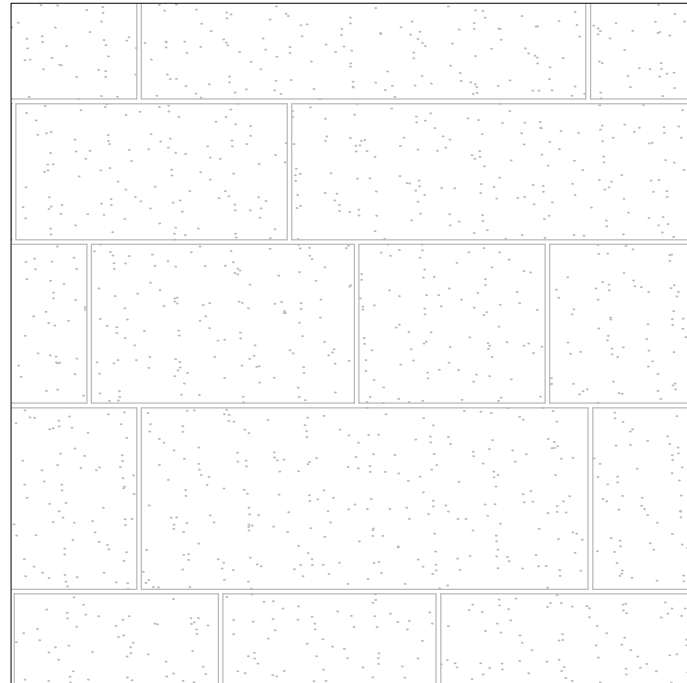

**P1** Lastrichino in pietra arenaria extra-dura fiammata - larghezza 30/35/40 lunghezza a correre sp. 8 cm

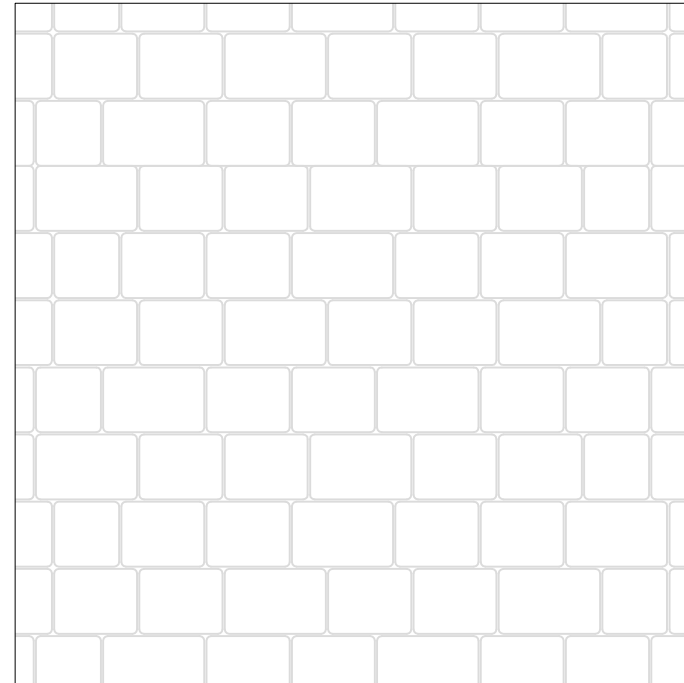

**P2** Pavimentazione in masselli autobloccanti serie anticati tipo "Vienna" mix antracite-fumo di Londra-fiammato fumo di Londra dim 21,8x13,9 - 17,9x13,9 - 13,9x13,9 - sp. 7 cm

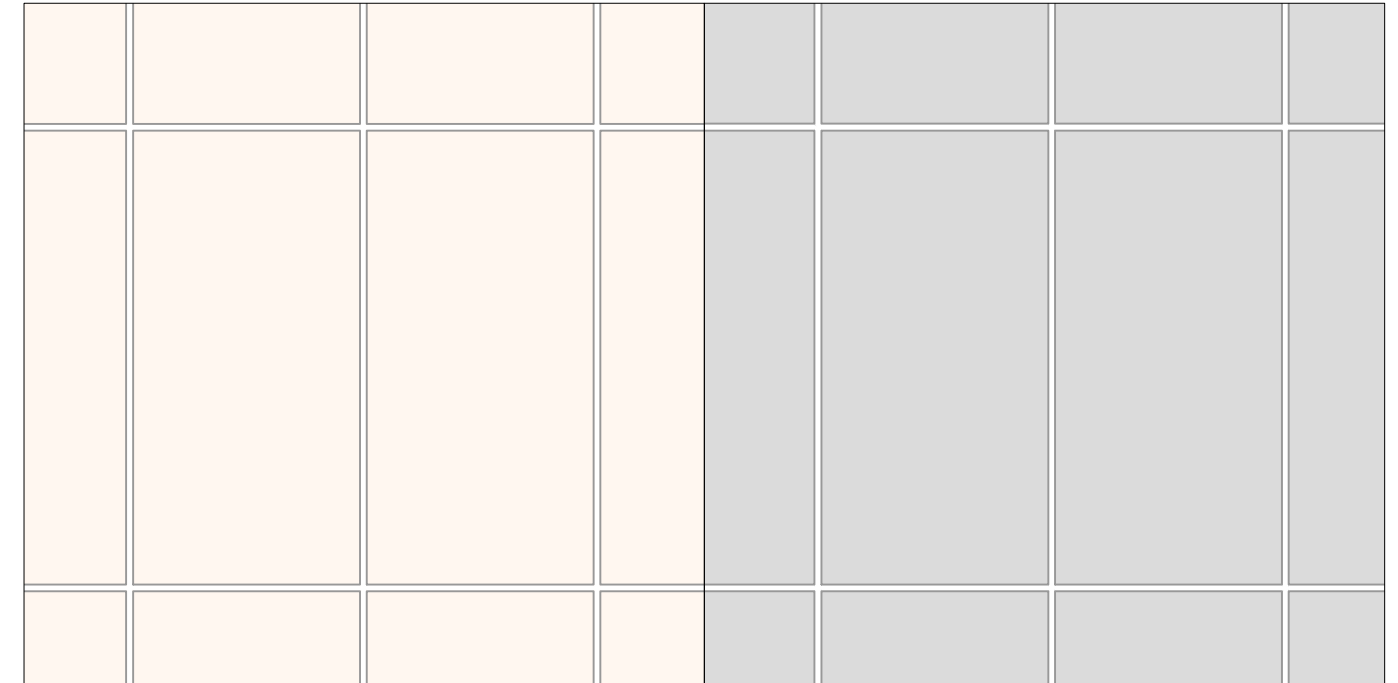

**P3.a** Pavimentazione in masselli in cls doppio strato finitura risaltata - Piastra 50x100 sp. 8 cm colore callida

**P3.b** Pavimentazione in masselli in cls doppio strato finitura risaltata - Piastra 50x100 sp. 8 cm colore grigio

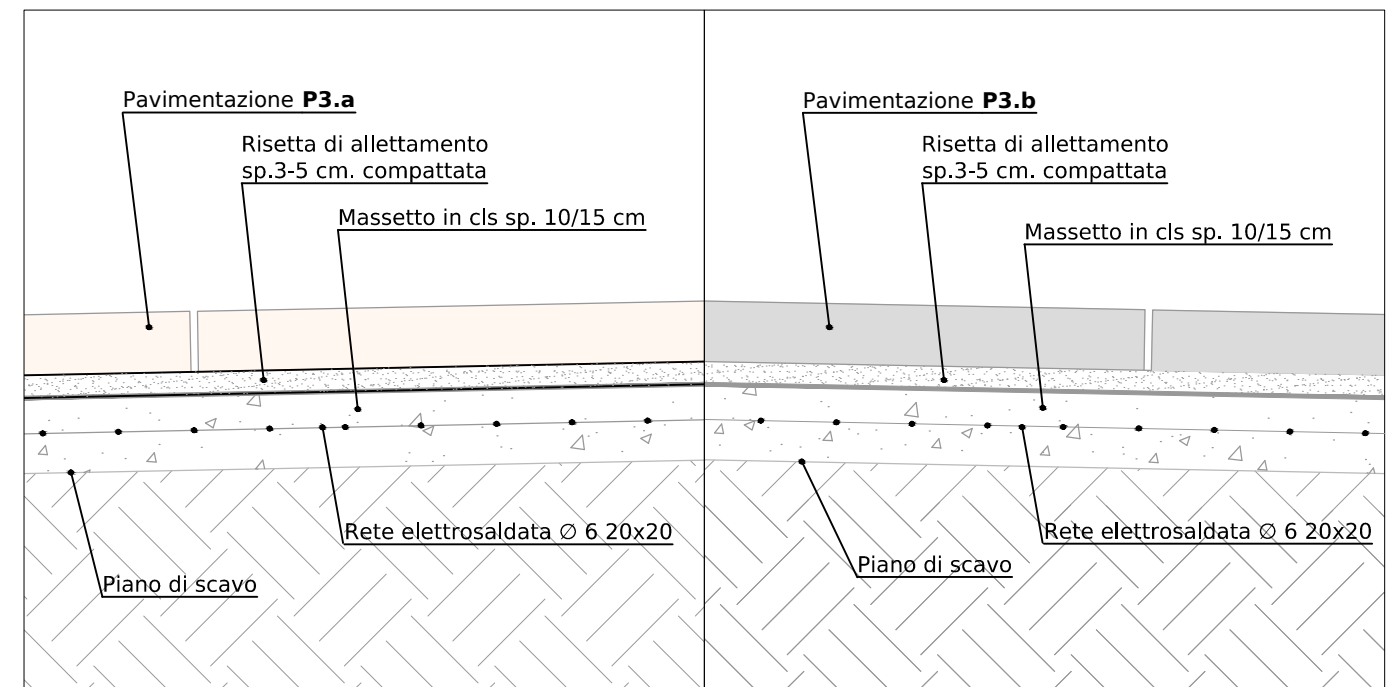
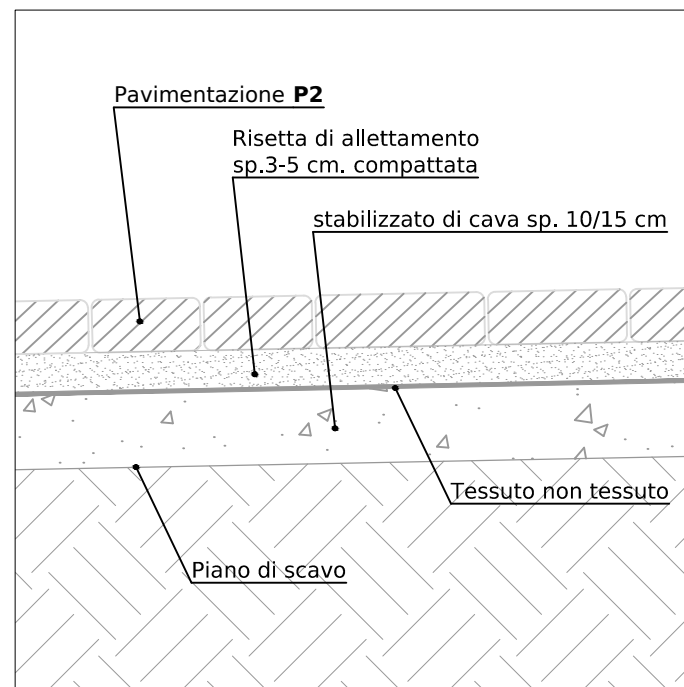
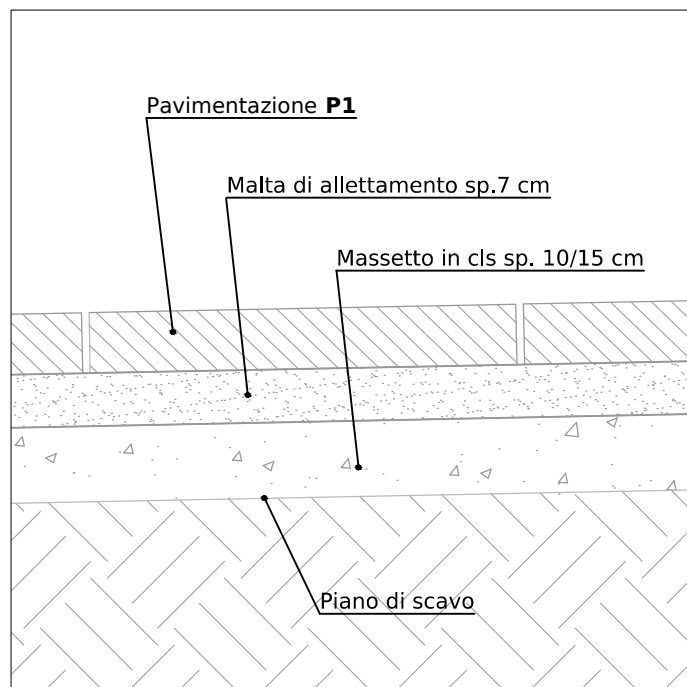

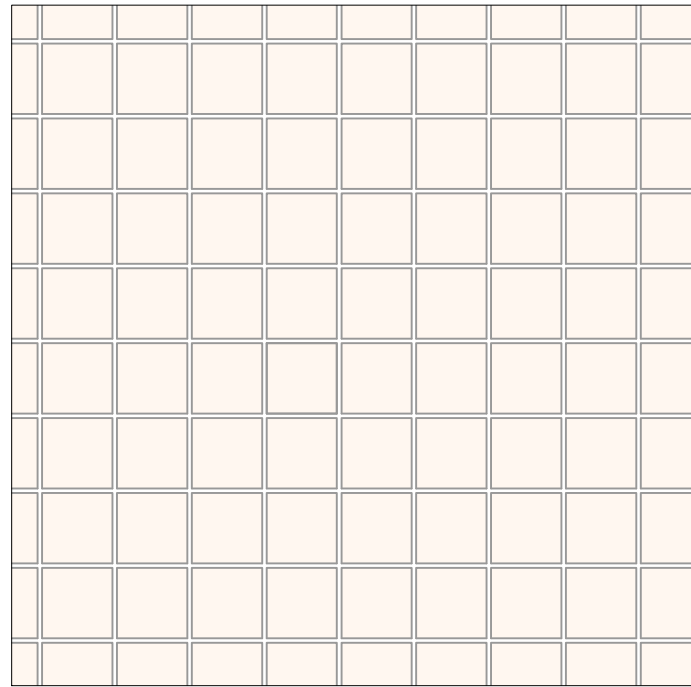

**P4** Pavimentazione in masselli in cls doppio strato finitura risaltata - Ciotolo 15x15 sp. 8 cm colore callida

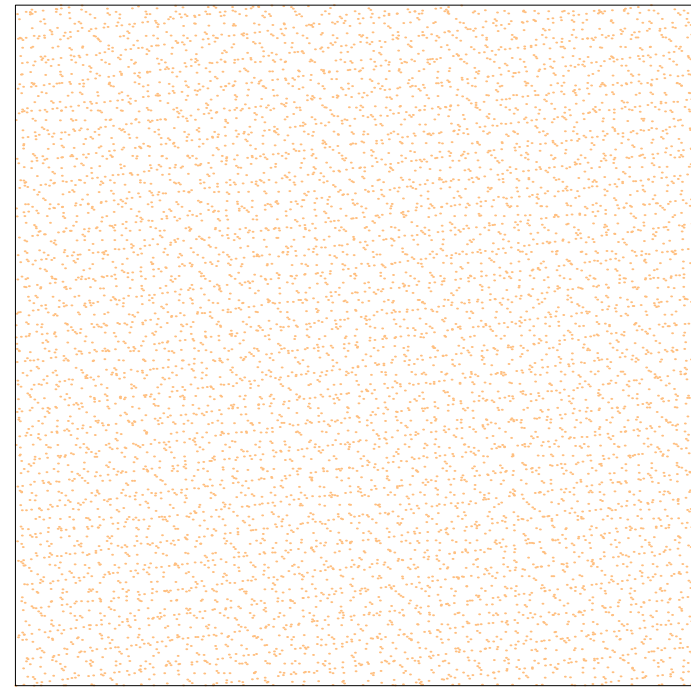

**P5** Sacatrasparent

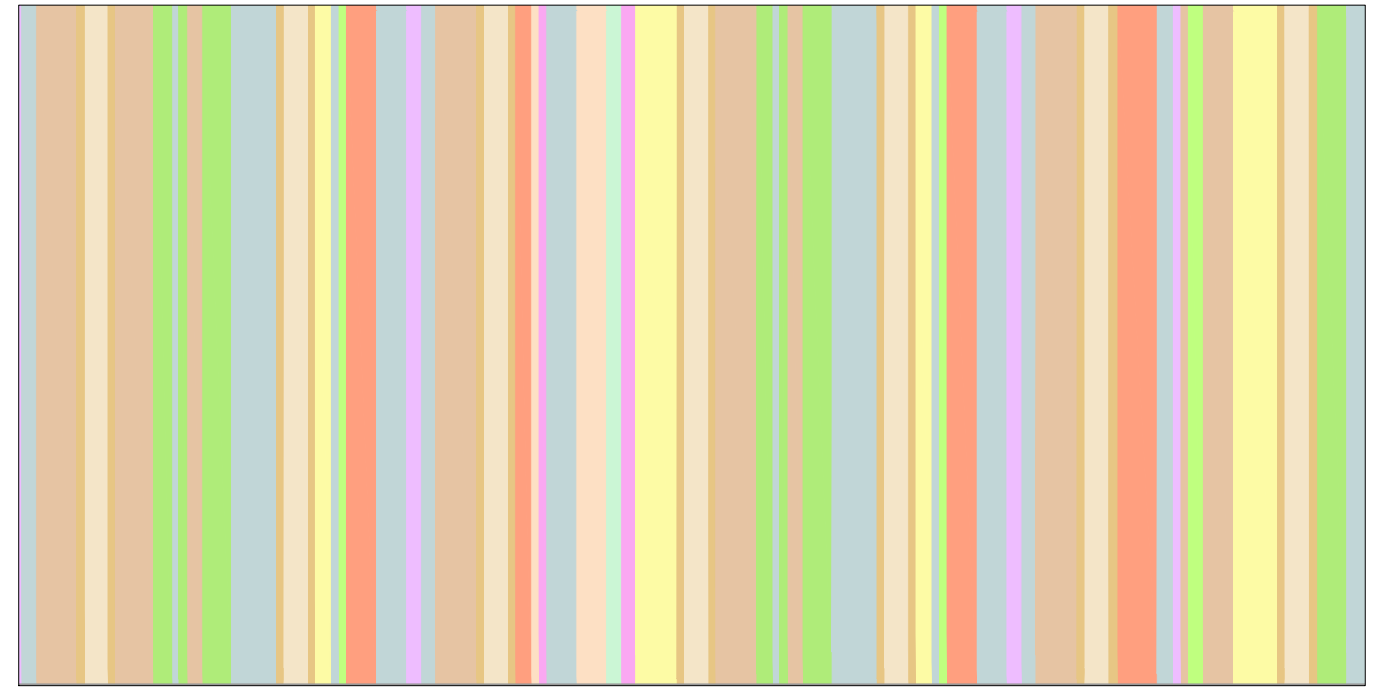

**P6** Pavimentazione in Gres porcellanato

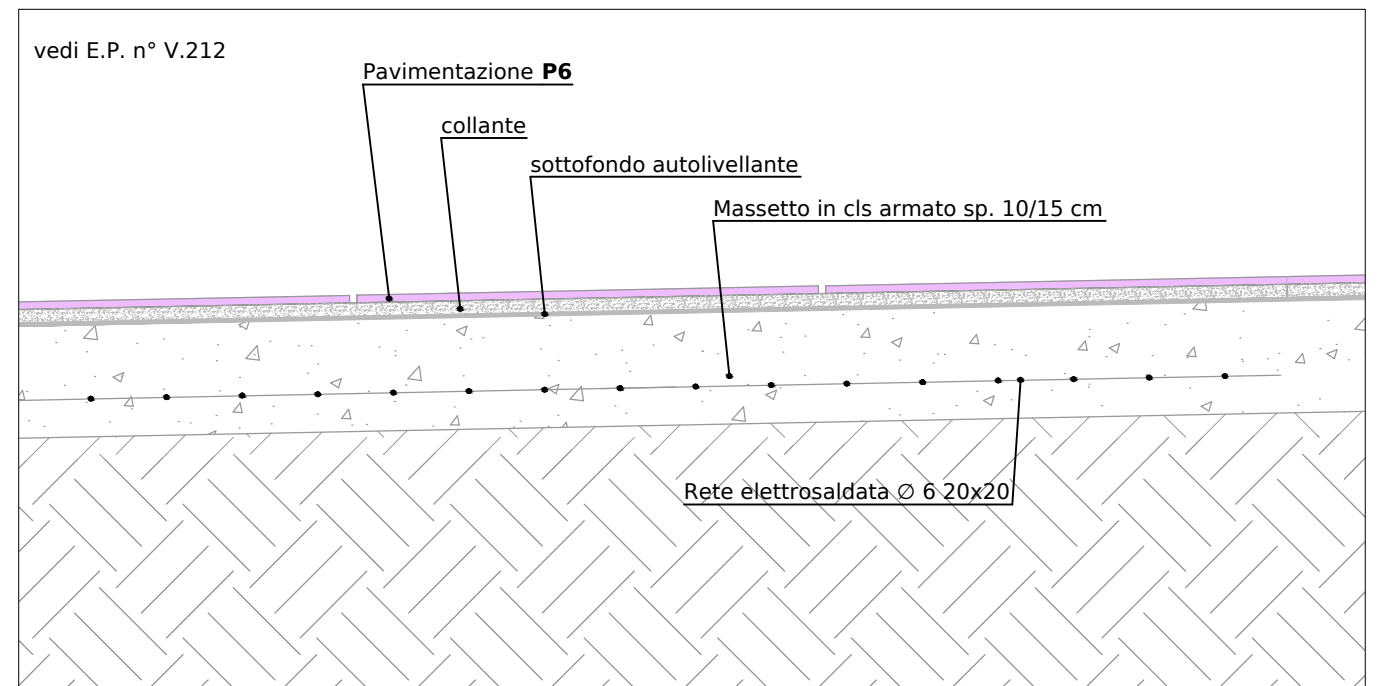
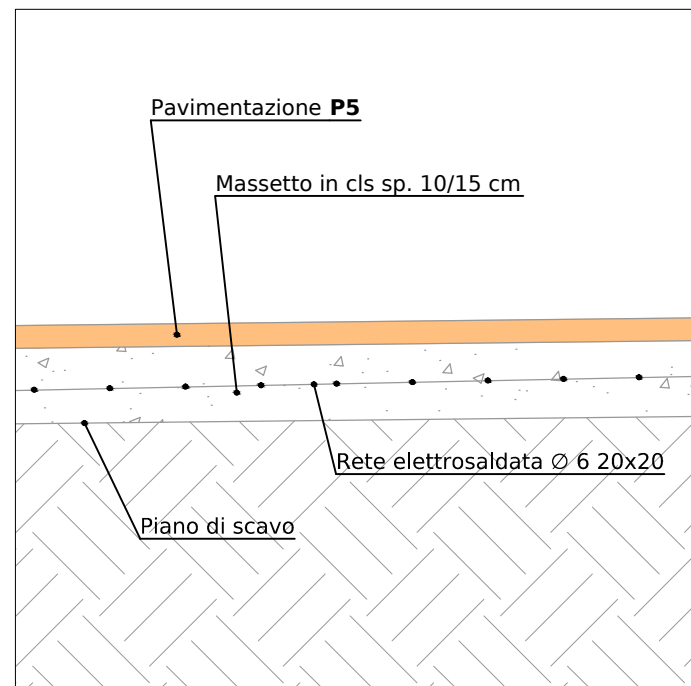
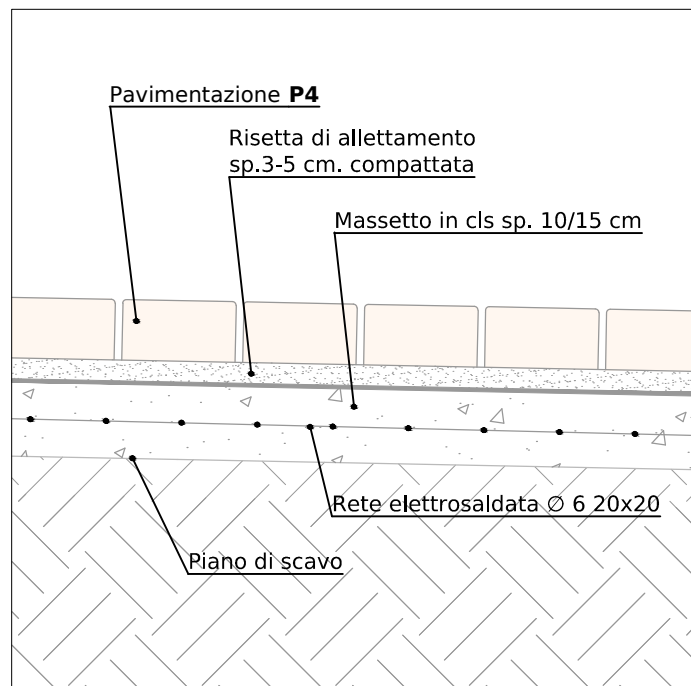

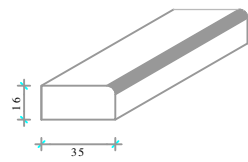

**L1.** Lista in pietra arenaria extradura fiammata lunghezza a correre

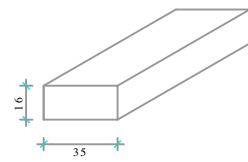

**L2.** Lista in pietra arenaria extradura fiammata lunghezza a correre

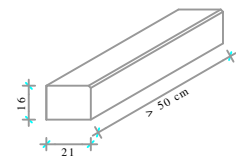

**L3.** Lista in pietra arenaria extradura fiammata lunghezza a correre

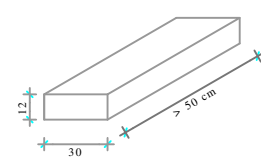

**L4.** Zanella in pietra arenaria extradura satinata lunghezza a correre

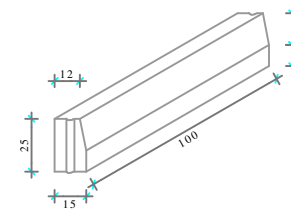

**L5.** Cordonato in cls

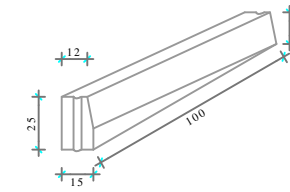

**L6.** Cordonato in cls - terminale per passaggio pedonale

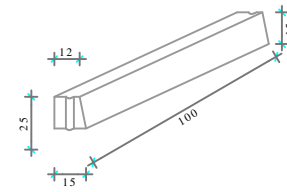

**L7.** Cordonato in cls - modulo ribassato per passaggio pedonale

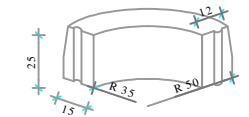

**L8.** Curva in cls - per passo carraio

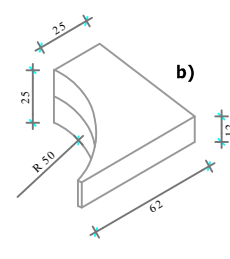
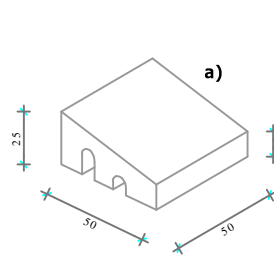

**L9.** Sistema scivolo passo carraio

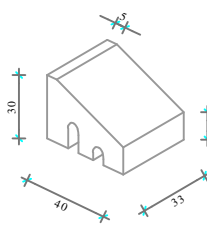
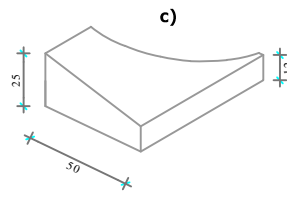

**L10.** Isola di traffico

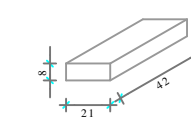

**L11.** Massello in cls doppio strato finitura risaltata  
a. colore calda  
b. colore grigio

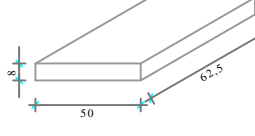

**L12.** Massello in cls doppio strato finitura risaltata  
a. colore calda  
b. colore grigio

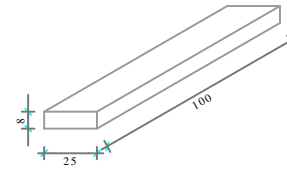

**L13.** zanella in cls

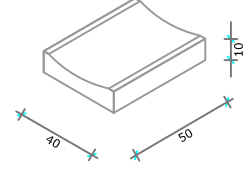

**L14.** Cunetta in cls Finitura liscia

**LS1.** Sistema scivolo passo carraio

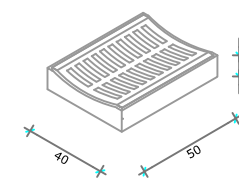
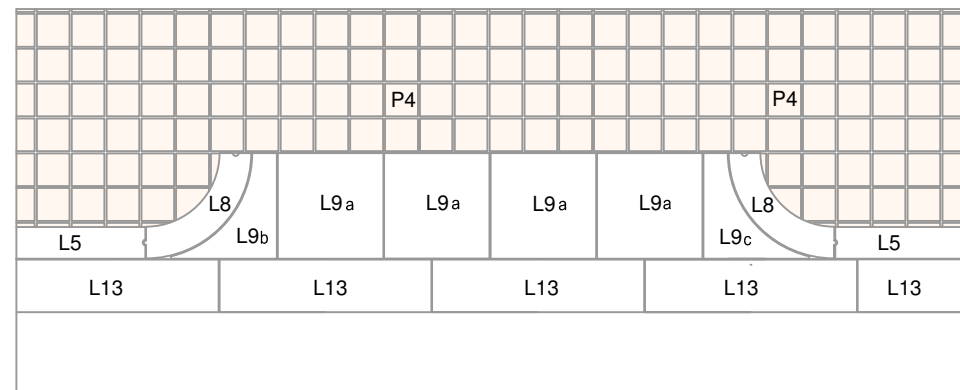

**L15.** Griglia concava in ghisa per sistema Cunetta

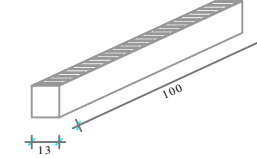

**L16.** Canaletta con griglia in ghisa

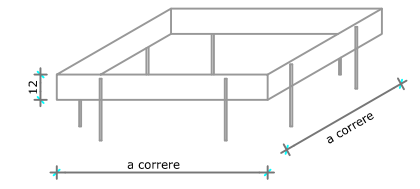

**L17.** Profilo in acciaio zincato spessore 3 mm h 12 cm con tondini in acciaio d. 10mm h max 30 cm.

**LS2.** Sistema abbattimento barriere architettoniche per attraversamento pedonale

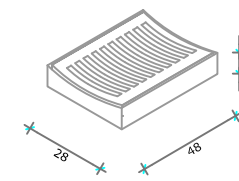
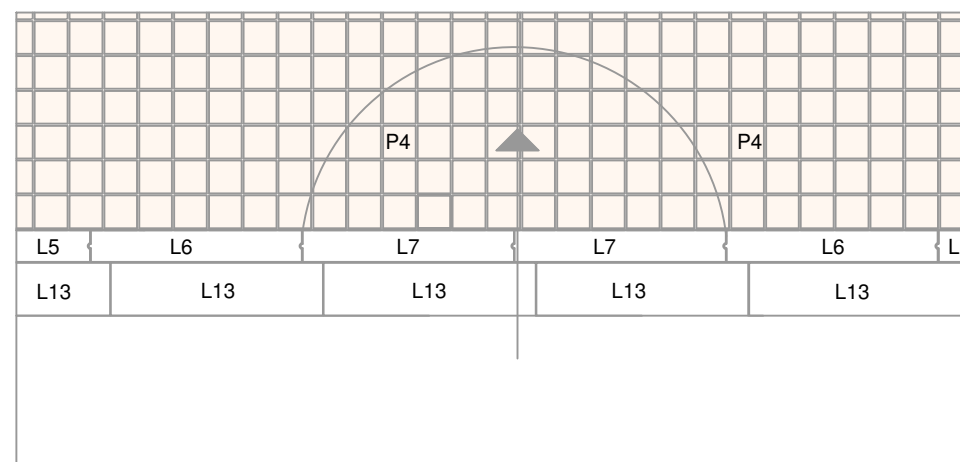

**L18.** Griglia concava in ghisa

**SE1** Panca in ghisa e doghe di legno l.188 cm

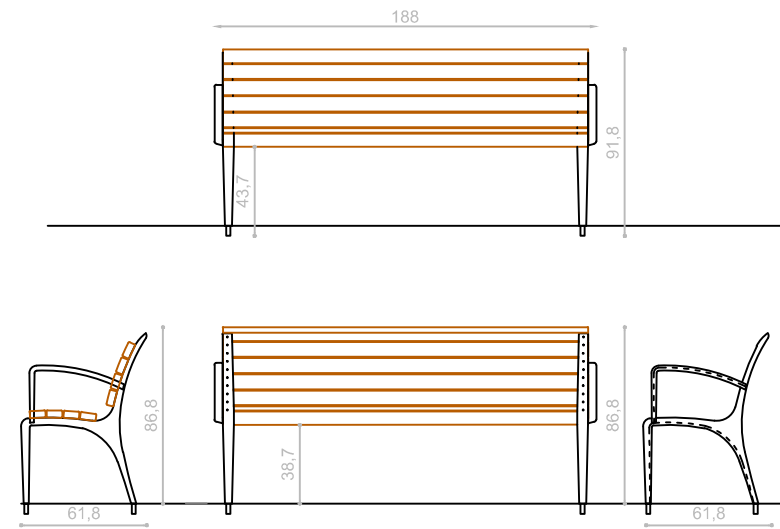

**SE2** Panca in ghisa e doghe di legno l. 80 cm

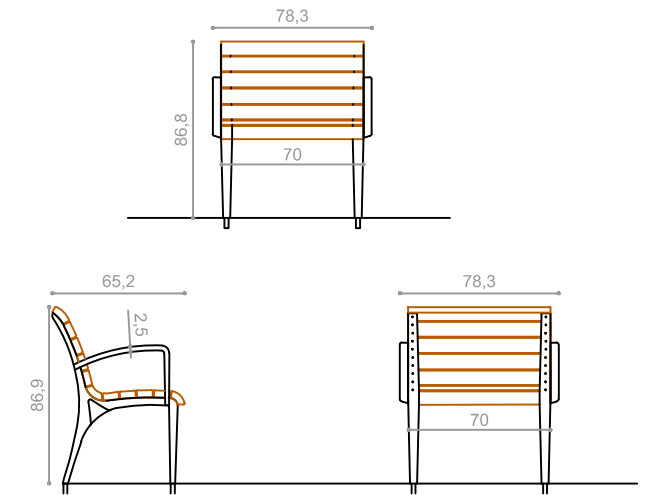

**SE3** Panca in aggregato di granito bianco sabbato l.255 cm

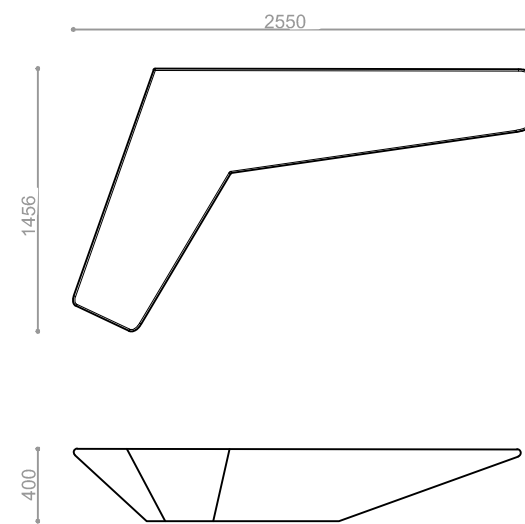





**AU1** Dissuasore in acciaio inox satinato con fittone e piastra copriforo h.100 cm

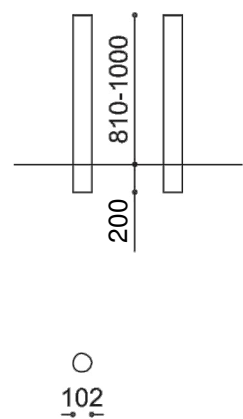

**AU2** Portabici in acciaio inox satinato h. 90 cm

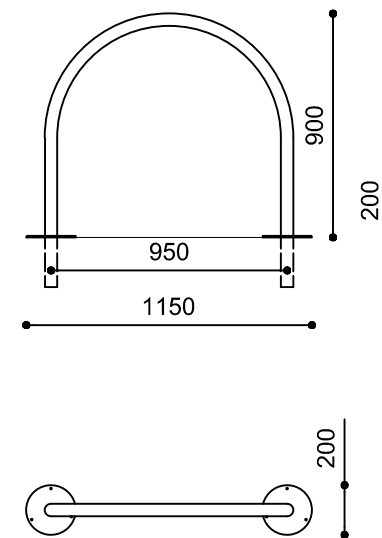

**AU3** Dissuasore mobile a scomparsa in acciaio inox satinato h.50 cm



**AU4** Grigliato salvapiante in acciaio corten l. 144 cm

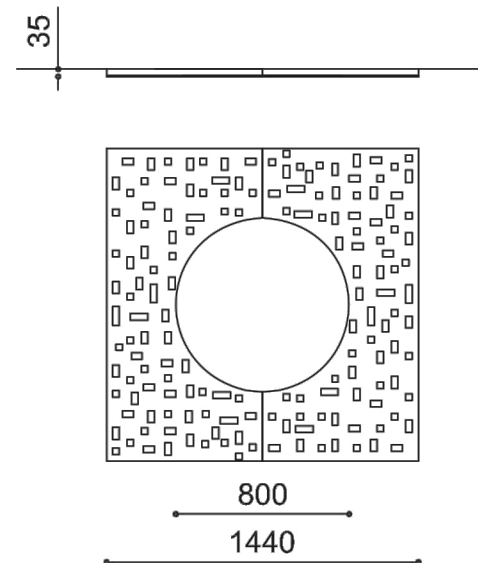

**AU5** Parapedonale in acciaio corten h.100 cm

GITTER 1M

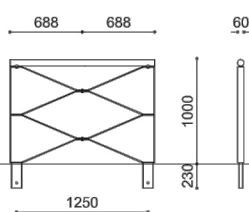

1376

GITTER 2M

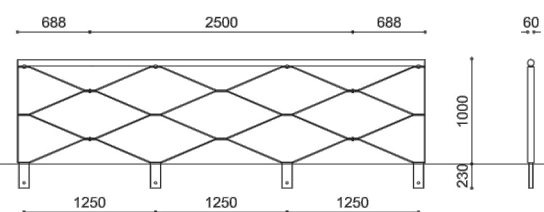

3876





**AP1** Apparecchio Illuminante aree carrabili

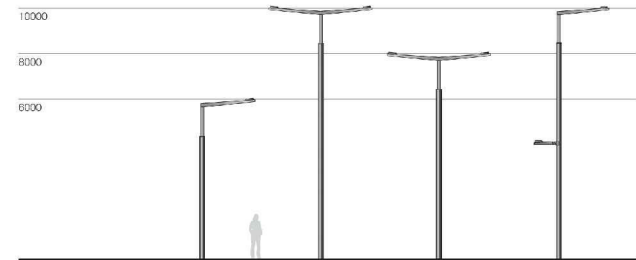

313x585

products.iguzzini.com/ir/road\_line

412

**AP2** Apparecchio Illuminante aree pedonali

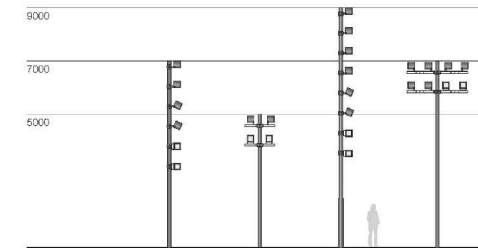

Pro  
# 192

products.iguzzini.com/2/multipro\_line 419

Auditorium del parco - L'Aquila, Italia  
Progetto architettonico: Renzo Piano Building Workshop  
1990 - Giuseppe Salotti



**AP4** Pozzetto Utente

**TIPOLOGIE DI COPERCHI STANDARD**

- A.** CHIUSINO IN GHISA SFEROIDALE CON CERNIERE IN BRONZO PORTATA D400 CERTIFICATO SECONDO UNI EN124 luce netta mm 485x407 H100



**AP3** Apparecchio Illuminante in ghisa

